

# Operating Manual



## Seed-Line

Soil Divider  
Seed Blower  
Vacuum Seed Counter



■ ■ ■ Made in Germany



# Table of Contents

<b>1</b>	<b>Soil Divider</b>	<b>5</b>
1.1	Delivery Scope	6
1.2	Appropriate Application	6
1.3	Misuse	6
1.4	Technical Data	6
1.5	Assembly	6
1.6	Transport	7
1.7	Operation	7
1.8	Cleaning	8
1.9	Declaration of Conformity	9
<b>2</b>	<b>Vacuum Seed Counter</b>	<b>11</b>
2.1	Delivery Scope	12
2.2	Appropriate Application	12
2.3	Misuse	12
2.4	Technical Data	12
2.5	Assembly	12
2.6	Transport	12
2.7	Operation	13
2.8	Setting of the suction power	14
2.9	Cleaning	14
2.10	Accessories	14
2.11	Setting Values Suction Power Controller	15
2.12	Declaration of Conformity	16
<b>3</b>	<b>Seed Blower</b>	<b>17</b>
3.1	Delivery Scope	18
3.2	Appropriate Application	18
3.3	Misuse	18
3.4	Technical Data	18
3.5	Assembly	19
3.6	Transport	20
3.7	Operation	20
3.8	Cleaning	20
3.9	Setting Values Fan Controller	20
3.10	Declaration of Conformity	21
<b>4</b>	<b>Service</b>	<b>23</b>



## 1 Soil Divider

With the soil divider, which is completely manufactured from stainless steel, the reliable and representative separation of samples becomes child's play.

Simply put the seed on the opened lid, and distribute it approximately even. When closing the lid, the seed will be divided into two even samples of the same size due to the construction and the 18 channels.

After the separation, the divided samples are located in the two laterally arranged drawers, from where they can be removed easily.

Easy cleaning without residues is ensured by the optimized construction without cavities. Additionally, all surfaces have been electro-polished. So, adhering residues are practically avoided.



## 1.1 Delivery Scope

The delivery scope includes:

- 1 × Soil divider with sample vessel
- 2 × Collecting vessels
- 1 × Operating manual

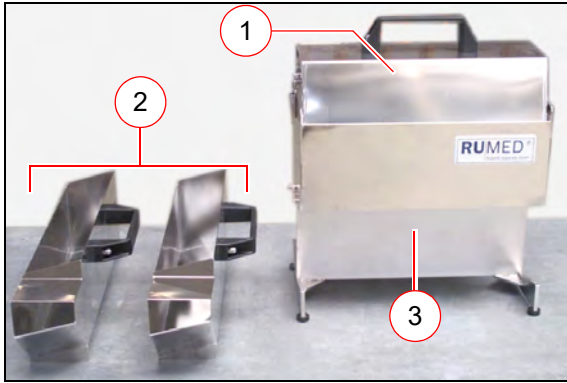

- (1) Sample Vessel  
 (2) Collecting vessels  
 (3) Soil Divider

## 1.2 Appropriate Application

The soil divider is exclusively used for representative separation of seed samples up to a maximum weight of 2 kg. So, the examination expenditure can be reduced to the required minimum.

Any other application is considered as misuse.

## 1.3 Misuse

It is not allowed to use the soil divider for separation of other material than seed samples.

Examples of material, which is considered as misuse:

- Abrasive material, such as sand or soil samples
- Liquids

## 1.4 Technical Data

H × W × D: 440 mm x 280 mm x 510 mm  
 Weight: 8.5 kg

### Packaging:

H × W × D: approx. 520 mm × approx. 500 mm  
 × approx. 400 mm  
 Weight: approx. 16 kg

## 1.5 Assembly

The component parts have been manufactured to fit exactly and can be inserted at the corresponding places.

How to assemble the soil divider:

1. Remove the component parts from the packaging.
2. If required, clean the collecting vessels and the sample vessel, *see paragraph 1.8*.
3. Place the soil divider on a solid and level surface.
4. Insert the collecting vessels into the provided recesses.  
 Observe the correct seat in the guides.



## 1.6 Transport

The soil divider is equipped with a carrying handle at the sample vessel. Please observe for transport:

- Close the bracket fasteners at both sides of the sample vessel, prior to lifting the soil divider.

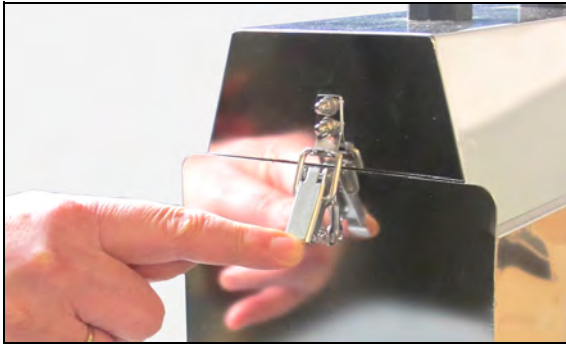

- Keep the soil divider upright to avoid that the collecting vessels will fallout.

## 1.7 Operation

1. Assemble the soil divider, see *paragraph 1.5*.  
If required, clean the soil divider, see *paragraph 1.8*.
2. Open both bracket fasteners.

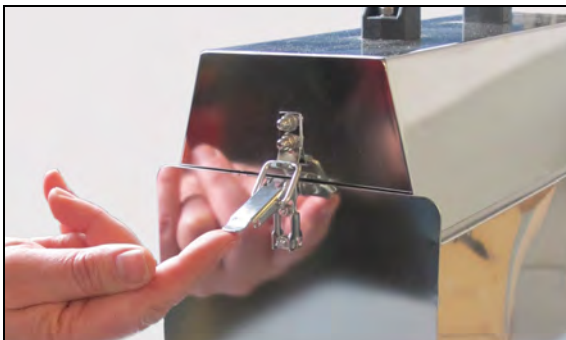

3. Open the sample vessel.

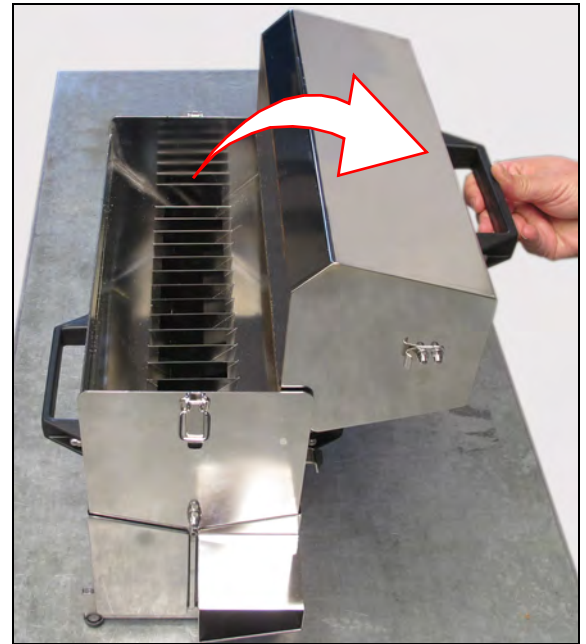

4. Dump the seed into the sample vessel.  
Distribute the seed evenly in the sample vessel.

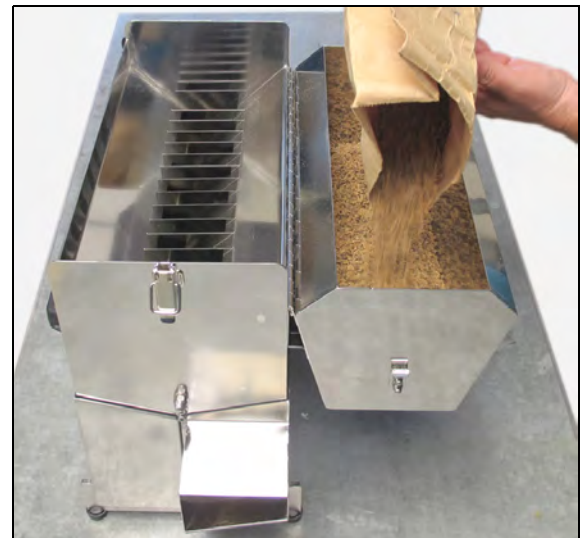

5. Turn the sample vessel over with a quick movement.

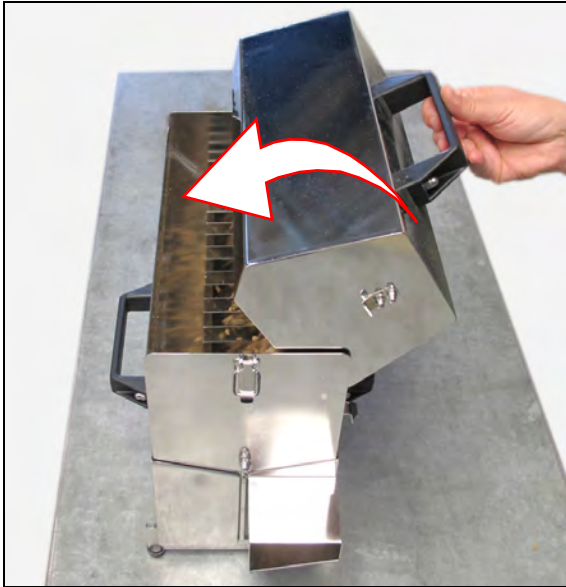

- The seed will be transferred into the separator, and it will be distributed evenly into the collecting vessels in the ratio 1:1 by means of the 18 channels.
6. First, remove the collecting vessel at the side with the hinges. Observe to keep the collecting vessel upright to avoid, that the divided sample will be spilled.



7. Tilt the collecting vessel laterally and empty it on the retained samples.



8. If the seed quantity in the second collection vessel is still too much, repeat the separation process until the desired examination quantity is obtained. Take care, that the opposite collection vessel is not overflowing. So, do not forget to empty it occasionally.

1<sup>st</sup> Separation: 50.0 % 50.0 %

2<sup>nd</sup> Separation: 75.0 % 25.0 %

3<sup>rd</sup> Separation: 87.5 % 12.5 %

9. Clean the soil divider after each change of the sample and check it for adhering residues, see *paragraph 1.8*.

## 1.8 Cleaning

After each change of the sample, the soil divider must be cleaned with a vacuum cleaner.

Particularly check the channels, the collecting vessels and the sample vessel for residues, which might contaminate the next sample.

After vacuuming, wipe the vessels out with a clean cloth and wipe the surfaces.

Never use compressed air for cleaning, since flying sample parts might contaminate other samples.



## 1.9 Declaration of Conformity



- English -

### EC- Declaration of conformity (2006/42/EC)

It is declared by the manufacturer **RUMED Rubarth Apparate GmbH** that all the relevant essential health and safety requirements of the EC machinery directive 2006/42/EC have been fulfilled for the following machine:

- **Manufacturer:** RUMED  
Rubarth Apparate GmbH  
Mergenthalerstr. 8  
DE- 30880 Laatzen
- **Machine / Type:** S9910-01
- **Serial Number:** see type plate

This declaration is no longer valid if the machine is modified without our consent.

Applied harmonized standards of guideline **Machinery Directive 2006/42/EC**:

- **ISO 12100** Safety of machinery - General principles for design
- **EN 349:1993** Minimum gaps to avoid crushing of parts of the human body
- **ISO 13857** Safety distances to prevent hazard zones being reached by upper and lower limbs

Authorized person for the technical documentation is the manufacturer.

Year of applying the CE Marking: 2017

Laatzen, 20.03.2017

Place, Date



Signature

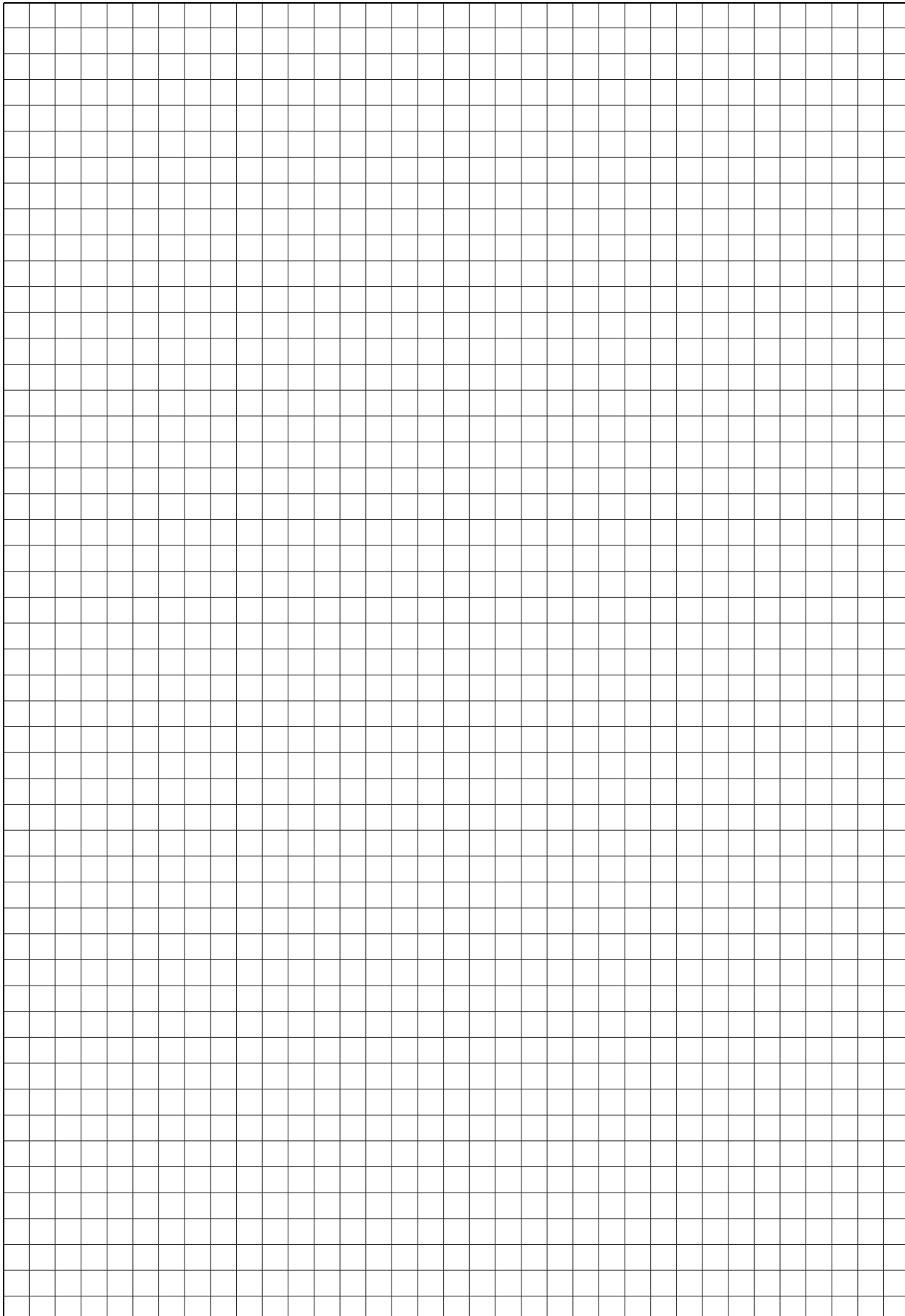

## 2 Vacuum Seed Counter

This extremely practical appliance simplifies the laborious and time-consuming counting and depositing of seed for germination.

It is particularly suitable for uniformly sized and smooth seed, such as grain, brassica and trifolium.

The counter consists of three components: a vacuum system with connecting hose, a series of counting heads corresponding to the different types of seed and of a valve interrupting the vacuum.

The intensity of the vacuum can be varied with a potentiometer.

The counting heads with 100, 50 or 25 bores are slightly smaller than the paper substrate, and they have a rim avoiding that the seed drops.

The diameter of the holes is adapted to the size of the seed and to the suction power of the vacuum.



## 2.1 Delivery Scope

The delivery scope includes:

- 1 × Vacuum seed counter
- 1 × Counting head 70 mm Ø for grass (100 bores 0.7 mm Ø each).  
 The bore size is engraved in the centre of the counting head.
- 1 × Counting head 70 mm Ø for clover (100 bores 1.0 mm Ø each).  
 The bore size is engraved in the centre of the counting head.
- 1 × Operating manual

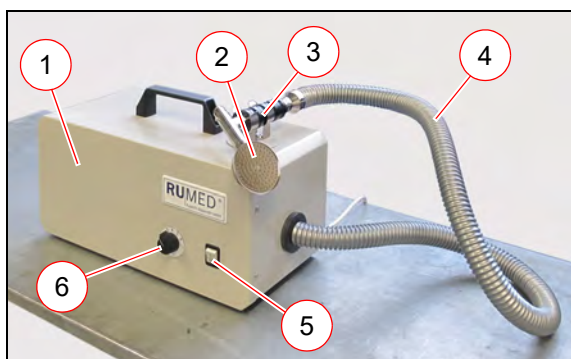

- (1) Vacuum Seed Counter
- (2) Counting Head
- (3) Hose Holder
- (4) Connecting Hose
- (5) Switch ON/OFF
- (6) Suction Power Controller

## 2.2 Appropriate Application

The vacuum seed counter is exclusively used for placing a defined quantity of seed in a specified arrangement on a suitable germination substrate using the appropriate counting head.

### ADVICE

Do not suck seed, the size of which is smaller than the bore diameter of the counting head.

Any other application is considered as misuse.

## 2.3 Misuse

It is neither allowed to use the vacuum seed counter as "vacuum cleaner", nor for sucking liquids.

## 2.4 Technical Data

H × W × D: 270 mm x 440 mm x 220 mm  
 Weight: 6 kg

Power Supply: 230 V/50 Hz

### Packaging:

H × W × D: approx. 450 mm × approx. 800 mm  
 × approx. 300 mm  
 Weight: approx. 14 kg

## 2.5 Assembly

The vacuum seed counter will be delivered completely finished.

The counting head can be replaced by simply removing and inserting it again.

## 2.6 Transport

The vacuum seed counter is equipped with a carrying handle. Please observe for transport:

- Fasten the connecting hose in the fixing device on the appliance.

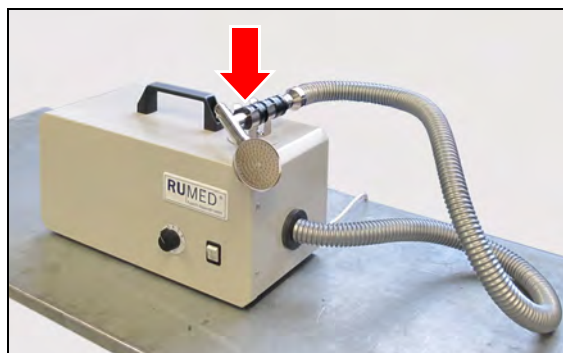

## 2.7 Operation

1. Chose the counting head with the quantity and the diameter of bores, which is suitable for the seed.

The bore diameter is engraved in the centre of the counting head.

(If you keep the corresponding list up to date, you will find the suitable counting head and its setting value for the suction power controller, see *paragraph 2.11.*)

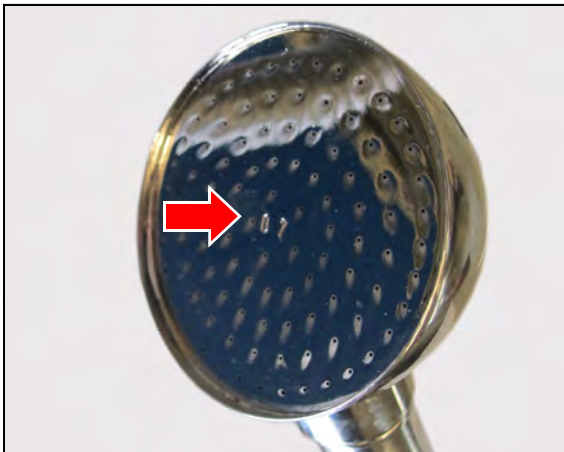

2. Insert the required counting head.
3. Connect the vacuum seed counter to the socket.
4. Switch the appliance on.
5. Set the suction power at the suction power controller, see *paragraph 2.8.* If you keep the corresponding list, see *paragraph 2.11.*
6. Turn the counting head with the bores upwards.

7. Dump the seed on the counting head.

### ADVICE

Never submerge the counting head into the seed, because the empty and light seed would then be sucked first.



8. Turn the counting head by 90 ° and carefully pat the excess seed off.



9. Check, if exactly one grain had been sucked on each bore.  
If required, correct it using tweezers.



10. Carefully place the counting head on the germination substrate and actuate the valve.  
Suction will be interrupted and the seed is placed on the germination paper.



11. Carefully lift the counting head and release the valve after that.
12. Check, if all grains have been put down (all bores are free).



## 2.8 Setting of the suction power

Each type of seed requires a different suction power, due to its size, shape and weight.

If sucked seed drops when the counting head is turned, the suction power is insufficient and must be increased gradually.

However, the suction power should not be higher than actually required.

Read the adjusted suction power at the suction power controller and note the value down, which is appropriate for the respective seed, see paragraph 2.11.

## 2.9 Cleaning

After each change of the sample, the vacuum seed counter must be cleaned.

Observe particularly, that there are no residues, which might contaminate the next sample.

## 2.10 Accessories

Accessories	Order No.
Counting head 70 mm Ø for tobacco (100 Bores, 0.4 mm Ø, each)	59930-10
Counting head 70 mm Ø for grass (100 Bores, 0.7 mm Ø, each)	59930-20
Counting head 70 mm Ø for clover (100 Bores, 1.0 mm Ø, each)	59930-30
Counting head 70 mm Ø for cabbage (50 Bores, 1.3 mm Ø, each)	59930-40
Counting head 70 mm Ø for wheat (50 Bores, 1.5 mm Ø, each)	59930-50
Counting head 70 mm Ø for peas (25 Bores, 2.0 mm Ø, each)	59930-60
Counting head 70 mm Ø in special design, bore diameter and bores customized	59930-70
Counting head in special design, rectangular, dimensions and bores customized	59930-99

Example Special Design:

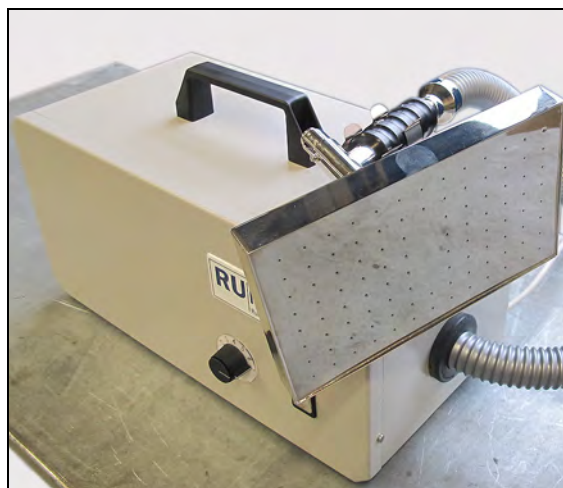



## 2.12 Declaration of Conformity



- English -

### EC- Declaration of conformity (2006/42/EC)

It is declared by the manufacturer RUMED Rubarth Apparate GmbH that all the relevant essential health and safety requirements of the EC machinery directive 2006/42/EC have been fulfilled for the following machine:

- **Manufacturer:** RUMED  
Rubarth Apparate GmbH  
Mergenthalerstr. 8  
DE- 30880 Laatzen
- **Machine / Type:** S9930-01
- **Serial Number:** see type plate

This declaration is no longer valid if the machine is modified without our consent.

Applied harmonized standards of guideline **Machinery Directive 2006/42/EC:**

- **ISO 12100** Safety of machinery - General principles for design
- **EN 349:1993** Minimum gaps to avoid crushing of parts of the human body
- **ISO 13857** Safety distances to prevent hazard zones being reached by upper and lower limbs

Applied harmonized standards of further valid guideline **Low Voltage Directive 2014/34/EU:**

- **EN 60204-1** Electrical equipment of machines

Applied harmonized standards of further valid guideline **EMC Directive 2014/30/EU:**

- **EN 61000-6-2** Immunity standard for industrial environments
- **EN 61000-6-4** Emission standard for industrial environments

Authorized person for the technical documentation is the manufacturer.

Year of applying the CE Marking: 2017

Laatzen, 20.03.2017

Place, Date



Signature



### 3 Seed Blower

The seed blower is used for quick separation of light and heavy grains.

The seed is poured into a drawer of the acrylic glass cylinder. The top of the cylinder is closed by means of a fine-meshed screen.

A speed-controlled fan in the cylinder creates a rising, constant air column.

Depending on its size and weight, the seed will fall into one of the 3 collecting vessels being attached to the cylinder. In this way, the light seed is led into the upper collecting vessel, and the heavy grain is led into the lower collecting vessel.

A further screen at the foot of the cylinder prevents the penetration of seed into the fan. After disconnection of the fan, the precipitate, consisting of the residues and sometimes also small stones, is retained on the screen.

The convenient wire bracket quick fastener facilitates the removal of the collecting vessels.



### 3.1 Delivery Scope

The delivery scope includes:

- 1 × Seed Blower
- 1 × Acrylic Glass Cylinder
- 3 × Numbered Seed Collecting Vessels
- 1 × Operating Manual

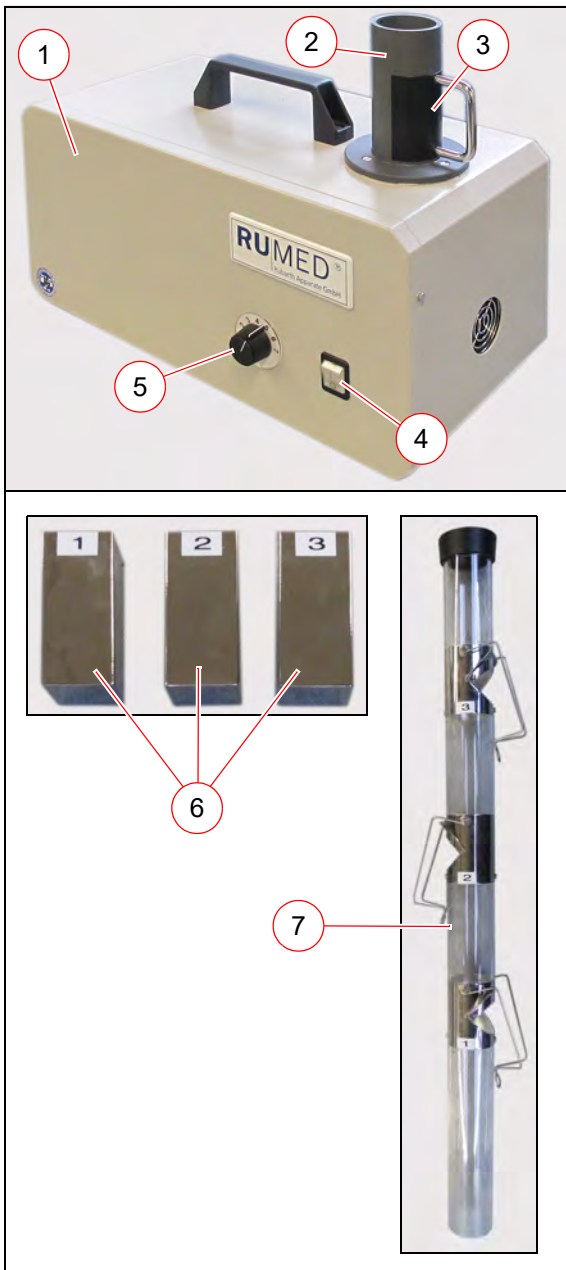

- (1) Seed Blower  
 (2) Acrylic Glass Support  
 (3) Sample Drawer  
 (4) Switch ON/OFF  
 (5) Fan Controller  
 (6) Seed Collecting Vessel  
 (7) Acrylic Glass Cylinder

### 3.2 Appropriate Application

The seed blower is exclusively used for separation of light and heavy grains.

Any other application is considered as misuse.

### 3.3 Misuse

It is not allowed to use the seed blower with liquids or abrasive material.

### 3.4 Technical Data

H × W × D: 1045 mm x 440 mm x 220 mm

Weight: 7.5 kg

Power Supply: 230 V/50 Hz

#### Packaging:

H × W × D: approx. 450 mm × approx. 800 mm  
 × approx. 300 mm

Weight: approx. 14 kg

### 3.5 Assembly

The component parts have been manufactured to fit exactly and can be inserted at the corresponding places.

How to assemble the seed blower:

1. Remove the component parts from the packaging.
2. Insert the acrylic glass cylinder into the acrylic glass support (avoid canting).
3. Screw the acrylic glass cylinder down.

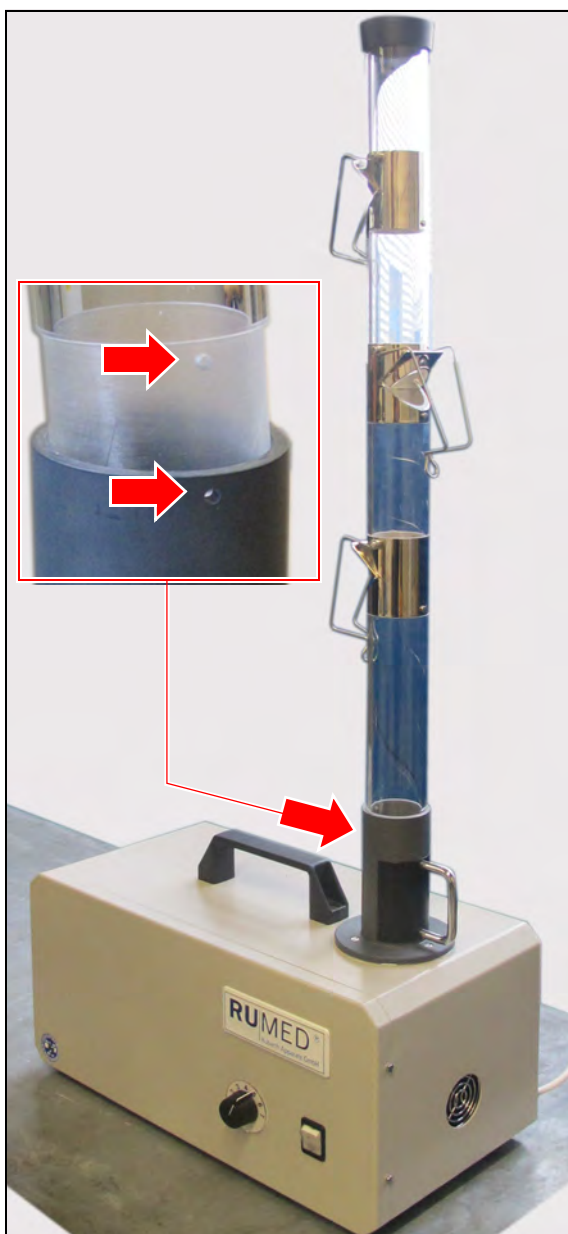

4. Fasten the numbered seed collecting vessels at the numbered supports.

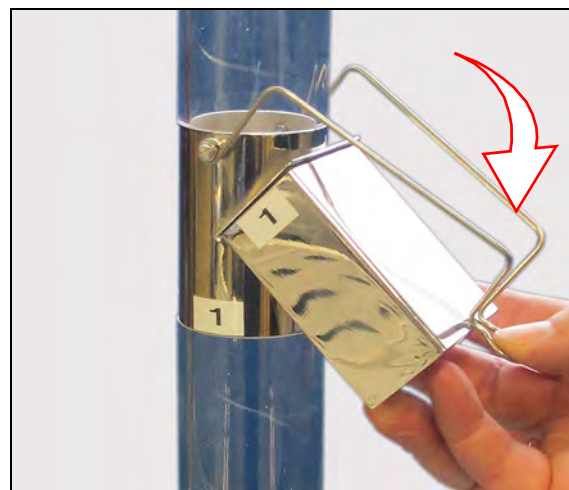
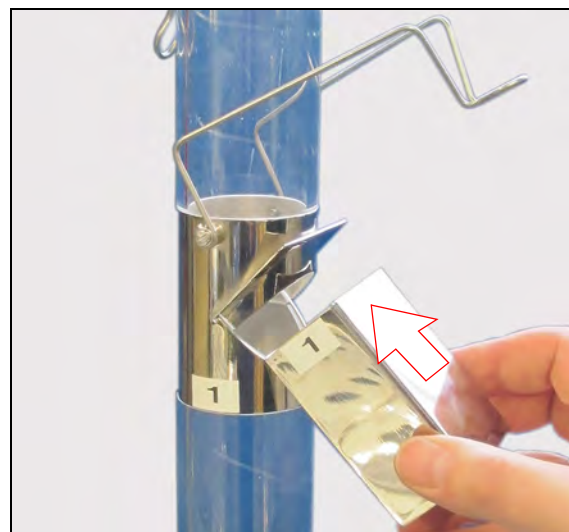

### 3.6 Transport

The seed blower is equipped with a carrying handle. Please observe for transport:

- Remove the seed collecting vessels.
- Loosen the screwing at the acrylic glass cylinder.
- Remove the acrylic glass cylinder.

### 3.7 Operation

1. Withdraw the sample drawer.
2. Fill the seed into the sample drawer.



3. Reinsert the sample drawer.
4. Insert all seed collecting vessels.
5. Connect the seed blower to the socket.
6. Set the fan controller to the lowest fan speed.
7. Switch the appliance on.
8. Gradually increase the speed at the fan controller, until the grains with the lightest weight will be blown up to the topmost seed collecting vessel.
9. Let the fan run for 120 seconds.
10. Switch-off the unit.
11. Withdraw the samples from the seed collecting vessels.
12. Clean the seed blower the after each change of the sample, see paragraph 3.8.

### 3.8 Cleaning

After each change of the sample, the seed blower must be cleaned with a vacuum cleaner.

Particularly check the sample drawer, the seed collecting vessels, the support of the acrylic glass cylinder and the acrylic glass cylinder for residues, which might contaminate the next sample.

Never use compressed air for cleaning, since flying sample parts might contaminate other samples.

### 3.9 Setting Values Fan Controller

Seed	Value Fan Controller

### 3.10 Declaration of Conformity



- English -

## EC- Declaration of conformity (2006/42/EC)

It is declared by the manufacturer RUMED Rubarth Apparate GmbH that all the relevant essential health and safety requirements of the EC machinery directive 2006/42/EC have been fulfilled for the following machine:

- **Manufacturer:** RUMED  
Rubarth Apparate GmbH  
Mergenthalerstr. 8  
DE- 30880 Laatzen
- **Machine / Type:** S9920-01
- **Serial Number:** see type plate

This declaration is no longer valid if the machine is modified without our consent.

Applied harmonized standards of guideline **Machinery Directive 2006/42/EC:**

- **ISO 12100** Safety of machinery - General principles for design
- **EN 349:1993** Minimum gaps to avoid crushing of parts of the human body
- **ISO 13857** Safety distances to prevent hazard zones being reached by upper and lower limbs

Applied harmonized standards of further valid guideline **Low Voltage Directive 2014/34/EU:**

- **EN 60204-1** Electrical equipment of machines

Applied harmonized standards of further valid guideline **EMC Directive 2014/30/EU:**

- **EN 61000-6-2** Immunity standard for industrial environments
- **EN 61000-6-4** Emission standard for industrial environments

Authorized person for the technical documentation is the manufacturer.

Year of applying the CE Marking: 2017

Laatzen, 20.03.2017

Place, Date

Signature

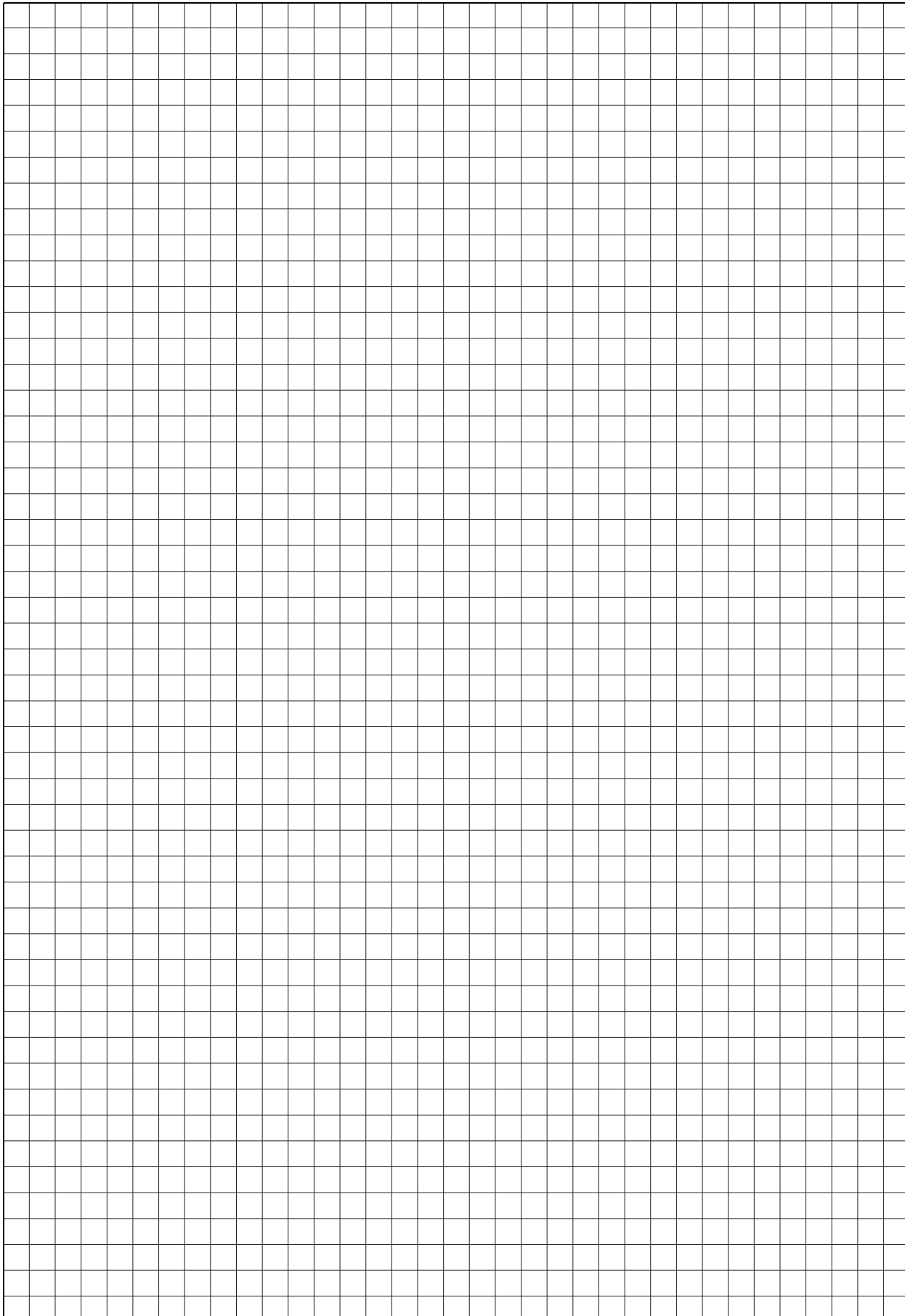

## 4 Service

In case of a service enquiry by means of our questionnaire ([www.rumed.de/serviceanfrage/](http://www.rumed.de/serviceanfrage/)) it is imperative to fill in the unit type (1) and the serial number (2). These details are indicated on the name-plate of your unit.

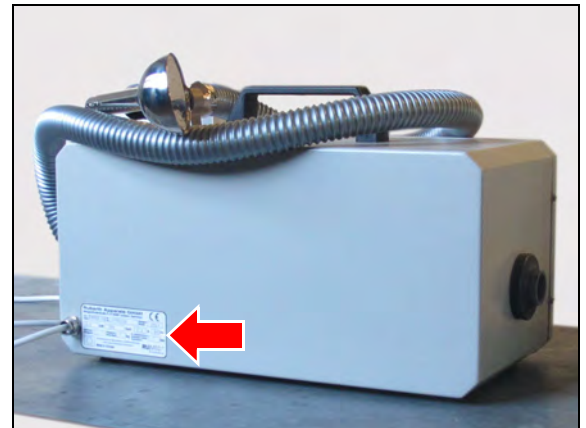
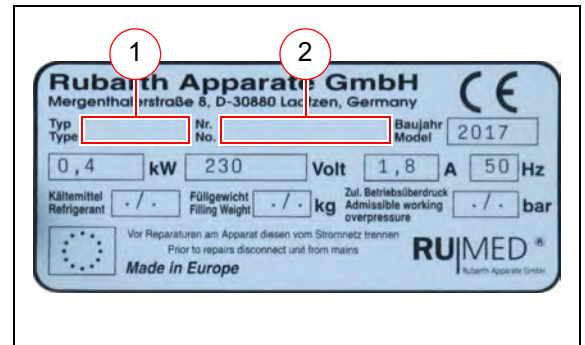

## Imprint

Rubarth Apparate GmbH  
Mergenthaler Str. 8  
D-30880 Laatzen/GERMANY

Phone: +49 511 866599 80  
Telefax: +49 511 866599 99  
E-Mail: [info@rumed.de](mailto:info@rumed.de)  
[www.rumed.de](http://www.rumed.de)